

# A9T

top-fixed internal sliding system

60kg max door panel weight

top-fixing allows for parallel-sliding panels

jump-proof enclosed box-section track

stainless steel bearings optional

# A9T: SLIDING SYSTEM

TOP-FIXED INTERNAL SLIDING SYSTEM FOR PANELS TO 60KG

A9T SPECIFICATIONS	
max panel weight	60kg
max panel height	3000mm

With top-fixed fastening the Centor A9T sliding system adds configuration options to those offered by A9S for interior sliding doors and shutters in commercial and residential applications. Using parallel tracks, two or more panels up to 60kg in weight can be slid off to one side. Substantial single doors or parting pairs on a single track are also possible depending on the size and nature of the opening required. With precision ground bearings, extruded aluminium or galvanised steel track and nylon-wheeled carriers Centor A9T is a durable solution for high-traffic applications.

## SECURE AND FLEXIBLE

Fully enclosed box-section track design ensures that carrier wheels cannot disengage. A selection of floor and wall-fixed guides suit grooved or non-grooved door panels while spring loaded guides running in a floor channel are an option for uneven floors. Panel height can be adjusted by tightening or loosening a single bolt.

## MATERIAL OPTIONS

Centor A9T carriers come standard with stainless steel brackets and four nylon tyred wheels. A choice of bearings in stainless or plated steel is available to suit the particular application. A choice of mill finish extruded aluminium track or sturdy galvanised steel ensures long life and corrosion resistance. Custom anodised and powdercoated finishes are available for tracking.

## SPECIFYING A9T

Architects and Designers can feel comfortable simply specifying "Centor A9T" and leaving detailed component selection to the builder, joiner or fabricator.



## A9T'S TOP-FIXED TRACKING

ADDS CONFIGURATION OPTIONS NOT AVAILABLE WITH A9S; TWO OR MORE PANELS UP TO 60KG IN WEIGHT CAN BE SLID TO ONE SIDE ON PARALLEL TRACKS.



CENTOR ARCHITECTURAL  
A9T SLIDING HARDWARE SYSTEM



# A9T: ARCHITECTURAL DETAIL

Downloadable DXF or DWG files ready for use in your own documentation are a convenient resource for architects and specifiers wishing to use Centor systems.

A9T DXF or DWG files can be downloaded from [www.centor.com.au/au/a9t\\_cad.html](http://www.centor.com.au/au/a9t_cad.html)

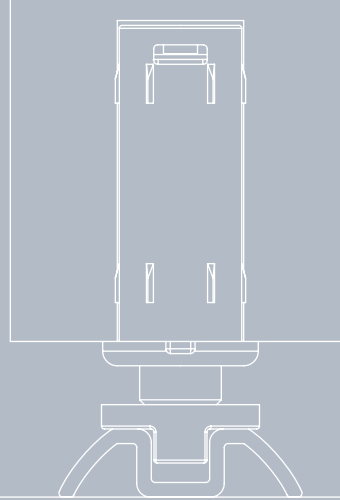

ALUMINIUM TRACK

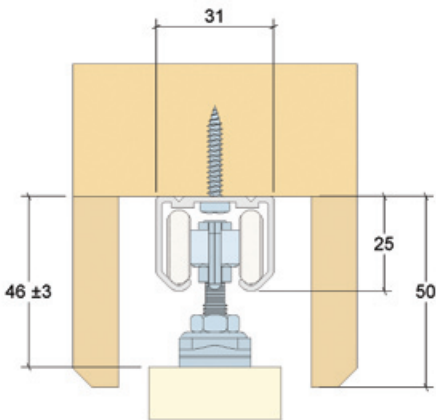

9F-001.DXF

STEEL TRACK

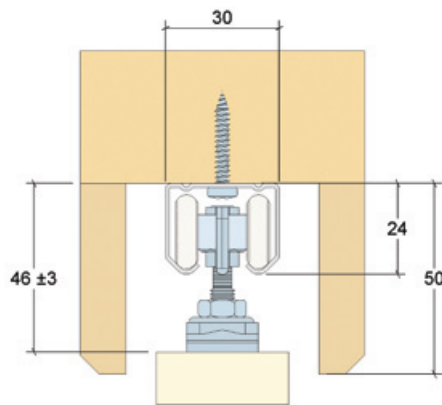

9F-002.DXF

2 versions of carrier available

94CCSM Stainless brackets.  
Plated bearings.

94CCSS Stainless brackets.  
Stainless bearings.

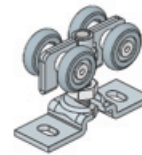

9GC FLOOR CHANNEL ON CONCRETE,  
CARPET OR TIMBER

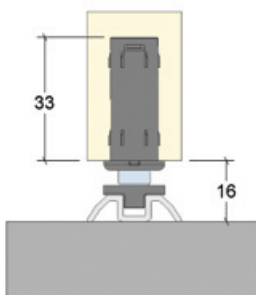

9F-003.DXF

MWT4CA FLOOR GUIDE IN TILE

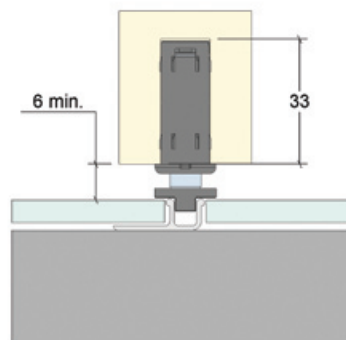

9F-004.DXF

9FCA FLOOR GUIDE IN TIMBER

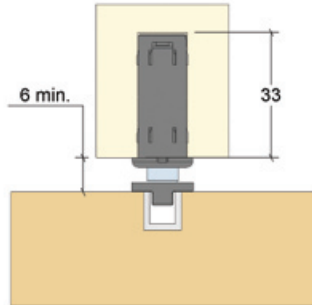

9F-005.DXF

1G GROOVE GUIDE ON TIMBER FLOOR

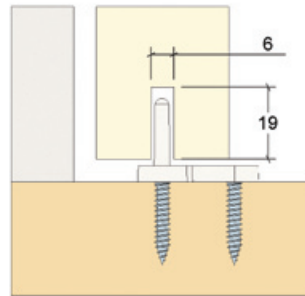

9F-006.DXF

1GW GROOVE GUIDE ON WALL

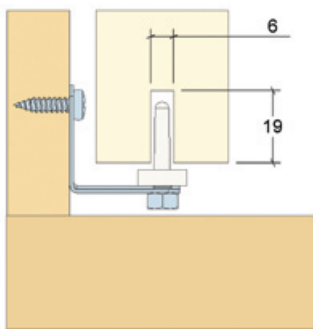

9F-007.DXF

1EG EXPANDING GUIDE ON TIMBER FLOOR

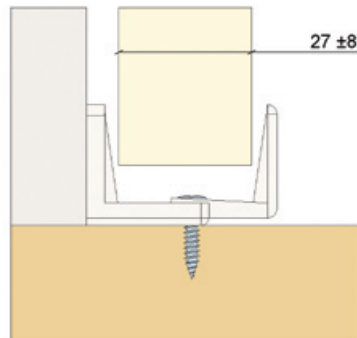

9F-008.DXF

1EGA EXPANDING GUIDE ON WALL

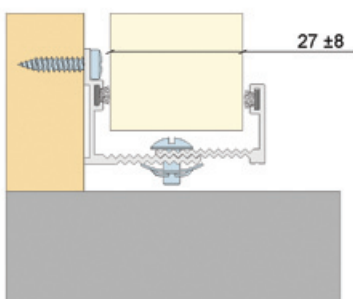

9F-009.DXF

1EG EXPANDING GUIDE ON WALL

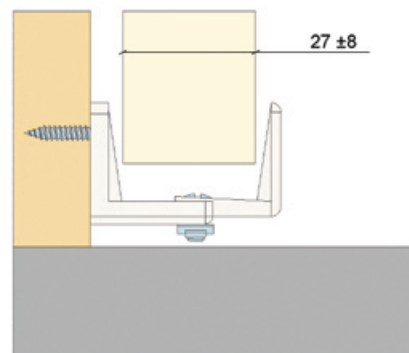

9F-010.DXF

## A9T: COMPONENT SELECTION

A9T is specified with 5 separate component groups. Components are required from each group to build an A9T sliding door system except when indicated otherwise.

- 1 **Track** – choose material, surface finish and size required to suit opening
- 2 **Carriers** – choose material and number required to suit panel layout
- 3 **Guides** – choose guiding method and number required to suit panel layout
- 4 **Channel\*** – choose fixing type, surface finish and size required to suit opening
- 5 **Accessories** – choose items which best suit opening and door panel requirements



\* Channels are an optional item

### SETS SELECTION

The A9T sliding door track system is also available as complete sets.

To specify a complete set, simply choose the set corresponding to the desired panel width. The set is supplied standard with the 94CCSM 4 wheel carrier with stainless componentry and plated bearings, together with track stops and the 1G moulded nylon guide. The track is supplied in mill finished aluminium in two alternative lengths and is easily cut to size with a hacksaw. If desired, the track can be anodised or powdercoated to suit. The track length should be twice the width of the intended panel.



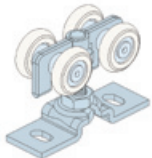

To specify the A9T as individual parts, see "Component Selection" section below.

PART	SELECT SET	PRODUCT CODE	SET DESCRIPTION
	up to 1000mm door	9FSA2	2000mm track set for single door containing: 1 x 9TA20 aluminium track 2 x 94CCSM carriers 1 x 1G guides 2 x 9TS stops 1 x screw pack
	up to 1500mm door	9FSA3	3000mm track set for single door containing: 1 x 9TA30 aluminium track 2 x 94CCSM carriers 1 x 1G guides 2 x 9TS stops 1 x screw pack

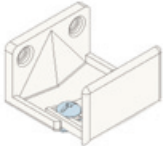
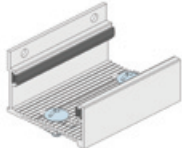

### CARRIERS

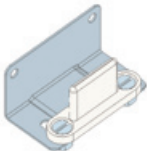
PART	SELECT WEIGHT	PRODUCT CODE	PART DESCRIPTION
	60kg	94CCSM	4 wheel carrier, stainless steel & mild steel bogey
	60kg	94CCSS	4 wheel carrier, stainless steel with stainless steel bogey



## GUIDES

PART	SELECT STYLE	GUIDE TYPE	PRODUCT CODE	PART DESCRIPTION
	non-grooved door	wall or floor fix	1EG	expandable guide, nylon, blister pack suits doors 19 – 35mm
	non-grooved door	wall or floor fix	1EGA	expandable guide, aluminium, blister pack (with brush) suits doors 19 – 35mm
	grooved door	floor fix	1G	floor fixed groove guide, nylon, blister pack suits doors with 6 x 19mm groove
	grooved door	wall fix	1GW	wall fixed groove guide, nylon suits doors with 6 x 19mm groove
	floor channel	floor fix	9SLG	spring loaded guide drill 12.7 x 33mm hole

## TRACK

PART	PRODUCT CODE	PART DESCRIPTION
	9TA20	2000mm aluminium track, mill
	9TA30	3000mm aluminium track, mill
	9TA40	4000mm aluminium track, mill
	9TA60	6000mm aluminium track, mill
	9TS09	915mm galvabond track
	9TS13	1255mm galvabond track
	9TS20	2000mm galvabond track
	9TS25	2500mm galvabond track
	9TS30	3000mm galvabond track
	9TS40	4000mm galvabond track
	9TS60	6000mm galvabond track

**OPTIONAL CHANNEL**

PART	PRODUCT CODE	PART DESCRIPTION
	9GC20N	2000mm aluminium surface channel, natural anodised
	9GC30N	3000mm aluminium surface channel, natural anodised
	9GC40N	4000mm aluminium surface channel, natural anodised
	9GC60N	6000mm aluminium surface channel, natural anodised
	9GC20W	2000mm aluminium surface channel, white powdercoat
	9GC30W	3000mm aluminium surface channel, white powdercoat
	9GC40W	4000mm aluminium surface channel, white powdercoat
	9GC60W	6000mm aluminium surface channel, white powdercoat
	9GC20B	2000mm aluminium surface channel, brown powdercoat
	9GC30B	3000mm aluminium surface channel, brown powdercoat
	9GC40B	4000mm aluminium surface channel, brown powdercoat
	9GC60B	6000mm aluminium surface channel, brown powdercoat
	9FCA2N	2000mm aluminium rebate channel, natural anodised
	9FCA3N	3000mm aluminium rebate channel, natural anodised
	9FCA4N	4000mm aluminium rebate channel, natural anodised
	9FCA6N	6000mm aluminium rebate channel, natural anodised
	9FCA2W	2000mm aluminium rebate channel, white powdercoat
	9FCA3W	3000mm aluminium rebate channel, white powdercoat
	9FCA4W	4000mm aluminium rebate channel, white powdercoat
	9FCA6W	6000mm aluminium rebate channel, white powdercoat
	9FCA2B	2000mm aluminium rebate channel, brown powdercoat
	9FCA3B	3000mm aluminium rebate channel, brown powdercoat
	9FCA4B	4000mm aluminium rebate channel, brown powdercoat
	9FCA6B	6000mm aluminium rebate channel, brown powdercoat
	MWT4CA	4000mm aluminium tile channel, natural anodised

\* Custom powdercoated or anodised available on request

## ACCESSORIES

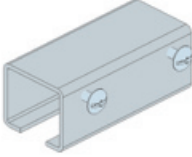
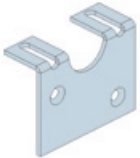
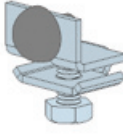
PART	PRODUCT CODE	DESCRIPTION
	9JB	steel track, joining bracket, zinc  Fitted to align steel tracks which are butted together, with carriers traversing the join.
	9AP	carrier adaptor plate for particle board doors  Adaptor plate used to secure top carrier plate to particle board, chip-board or MDF.
	9TS	track stop, zinc  Used to stop doors at end of track, or where two doors meet together on a single track.

## INSTALLATION

### FLOOR GUIDE

#### Installation using wall / floor guide

Separate top plate from carrier, fit top plate to door(s), feed carriers and stops into track, fit track, hang door(s), adjust carrier to align door, fit guide, adjust guide to remove excess play, locate and tighten stops.

#### Installation using 9SLG spring loaded guide

Separate top plate from carrier, fit top plate to door(s), fit bottom spring-loaded guide in each bottom corner of door rail, feed carriers and stops into track, fit track and channel, hang door(s), adjust carrier to align door, locate and tighten stops.

#### To fit 1G guide:

- 1 Fit screw A
- 2 Rotate guide sideways to remove excess play, then fit screw B.

